

Frequency Bandwidth	Maximal radiation Transmitting power
2400MHz-2480MHz	10dBm

41341-36OSHLU
45582705-01

APP control
Easy Smartphone
and Voice Control



compatible with
Alexa
compatible with
Google Assistant
zigbee

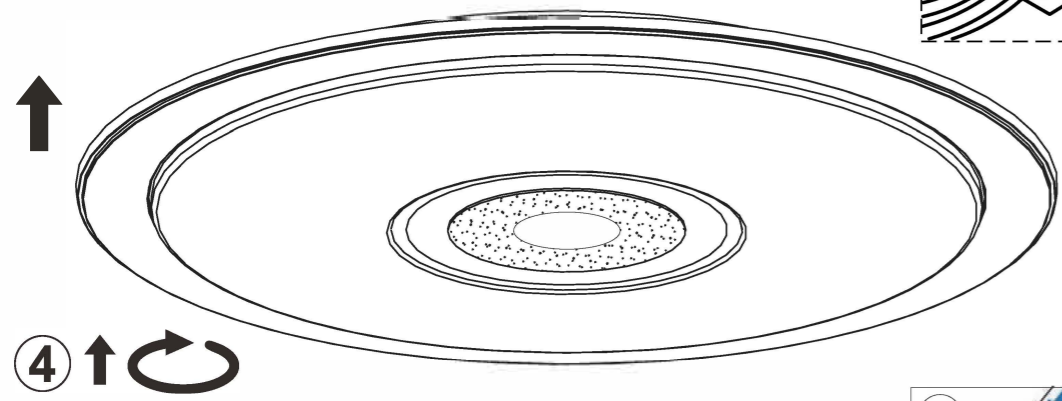
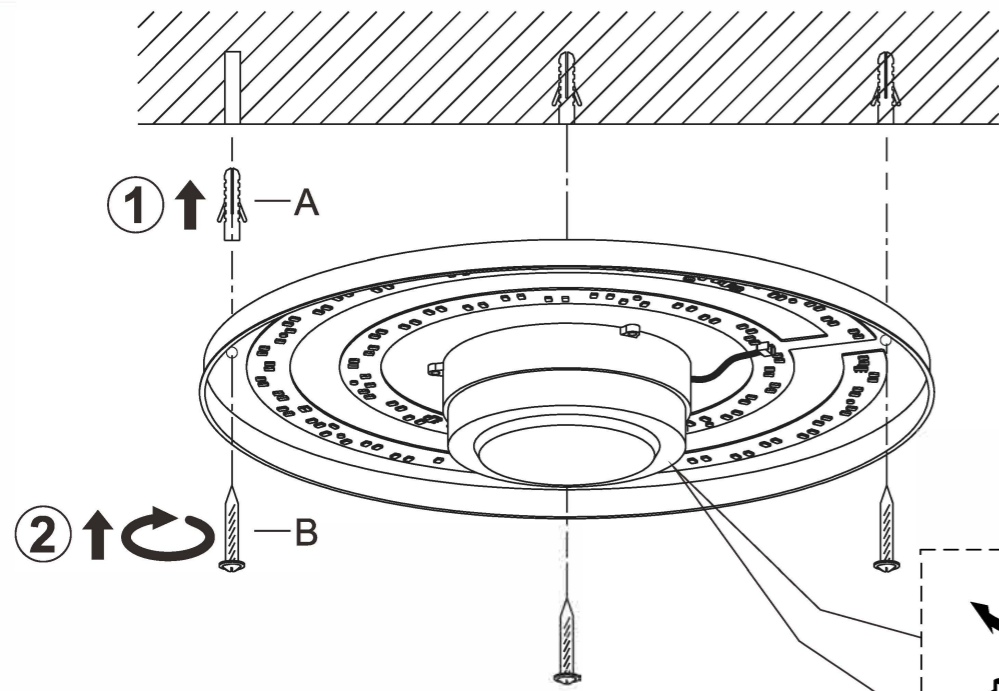

4 ↑ ↻

spare parts		
code		
A		x3PCS
B		x3PCS
C		x1PC
D		x2PCS

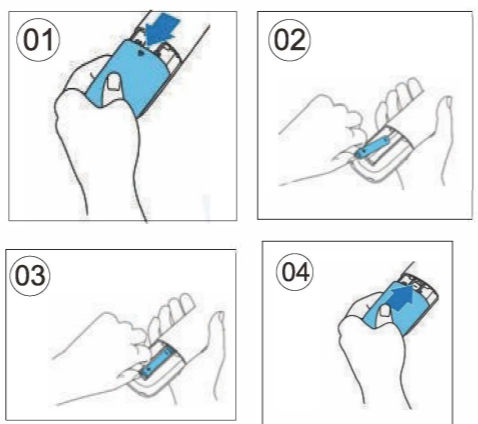

D =2 x AAA 1,5V battery incl

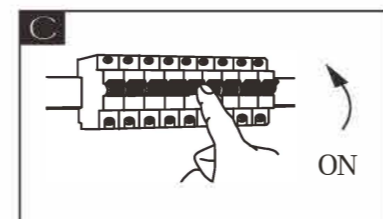

Reset remote control

Download Tuya App:



Functional Video:



Tuya App - Pairing Process

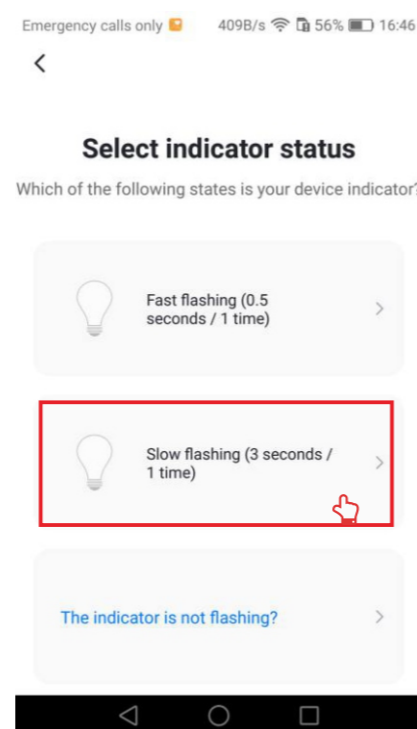
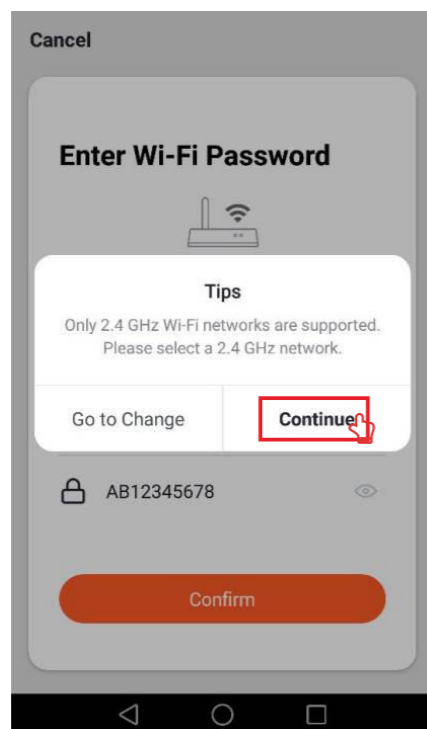
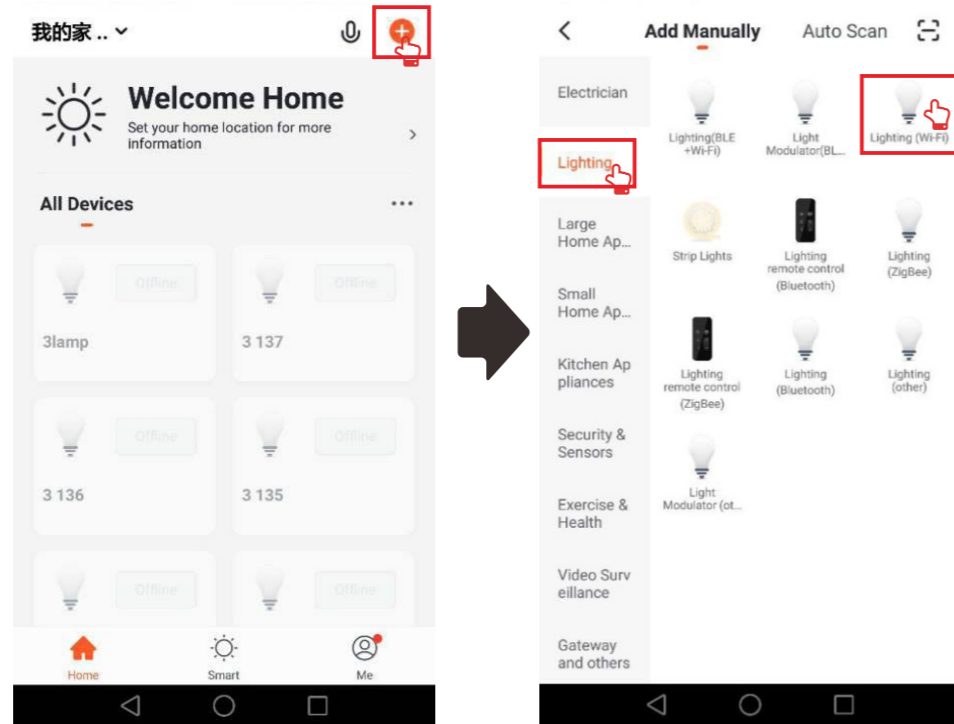

Turn on the lamp wait for 10s

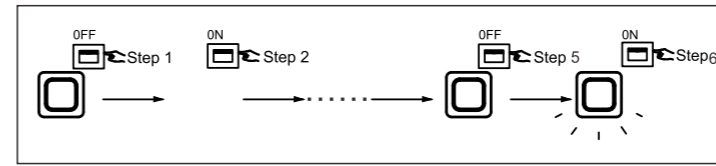

press for 6 times



lamp blinking



Connect the phone's Wi-Fi to the device's hotspot

1. Connected phone to the hotspot shown below

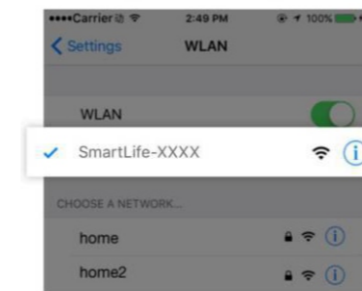

2. Go back to the App and continue to add devices

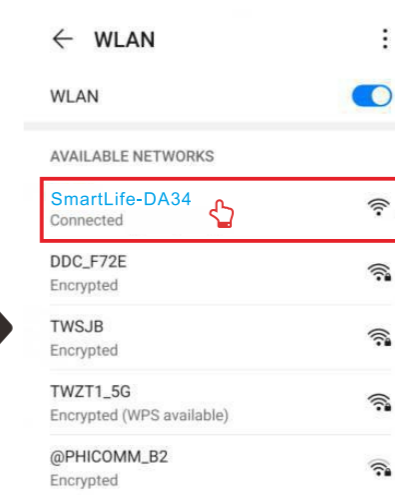
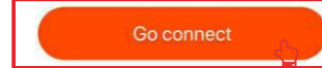

Connecting

Make sure your router, mobile, and device are as close as possible

100%

- ✓ Device found
- ✓ Register device to the smart cloud
- ✓ Initializing device

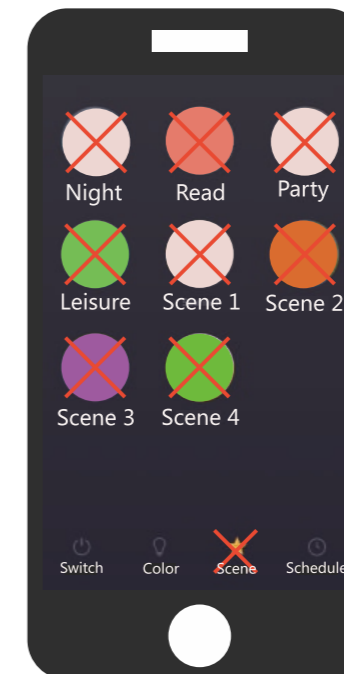
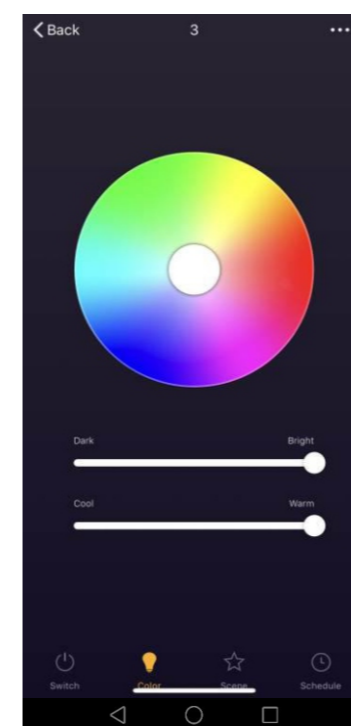

"Scene" mode NO FUNCTION

Reminder: The first connection may take a few minutes, please be patient.

PS: The Bluetooth speaker function of the lamp needs to be connected separately.

Step: Open the Bluetooth function of the phone, look for the bluetooth with the name: "41341-36OShLU" and connect, then you can use this function

Lichtquelle/Light source:

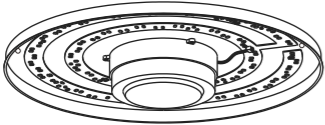

DEU:

Lichtquelle:

Die Lichtquelle ist nicht tauschbar, weil sie konstruktionsbedingt fest mit dem umgebenden Produkt verbunden ist.

Dieses Produkt enthält eine Lichtquelle der Energieeffizienzklasse <E>.

 Austausch des Betriebsgeräts durch einen Professionisten.

 Leuchtmittel nicht austauschbar.

GBR:

Light source:

The light source is not interchangeable because it is determined by the surrounding product design. This product contains a light source of energy efficiency class <E>.

 Replaceable control gear by a professional.

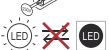
 Non replaceable light source.

BIH:

Izvor svjetla :

Izvor svjetla nije zamjenjiv , jer je konstrukcijski pričvršćen na proizvod .

Ovaj proizvod sadržava izvor svjetlosti klase energetske učinkovitosti <E>.

 Izmjenu pogonskog uređaja smije izvršiti i samo profesionalna osoba

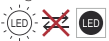
 LED žarulje nije moguće zamjeniti

BG:

Източник на светлина:

Източникът на светлина не може да се подменя, тъй като поради конструкцията си е трайно фиксиран към заобикалящия го продукт.

Този продукт включва светлинен източник с клас на енергийна ефективност <E>.

 Смяна на управляващото устройство от професионалист.

 Източникът на светлина не може да се подменя.

CZ:

Zdroj světla:

Světelný zdroj není možné vyměnit, protože je díky své konstrukci pevně spojený s produktem. Tento výrobek obsahuje světelný zdroj s třídou energetické účinnosti <E>.

 Výměna předřadníku jen odborníkem.

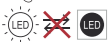
 Světelný zdroj není vyměnitelný.

 Světelný zdroj není vyměnitelný.

 Světelný zdroj není vyměnitelný.

RO:

Sursa de lumina:

Sursa de lumina nu este inlocuibila ea fiind parte constructiva a produsului

Acest produs conține o sursă de lumină cu clasa de eficiență energetică <E>.

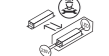
 Schimbarea unitatii de control trebuie facuta doar de catre personal specializat

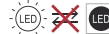
 Sursa de lumina nu poate fi schimbata

RUS:

Источник света:

Источник света не является взаимозаменяемым, поскольку это определяется конструкцией смежного продукта.

Данный продукт содержит источник света класса энергоэффективности <E>.

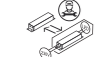
 Замена регулировочного механизма специалистом.

 Незаменяемый источник света.

SRB:

Izvor svetlosti:

Izvor svetlosti nije zamenljiv, jer je zbog svog dizajna čvrsto povezan sa proizvodom koji ga opkružuje.

Ovaj proizvod sadrži izvor svetlosti klase energetske efikasnosti <E>.

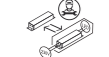
 Zamena upravljačkog uređaja od strane profesionalca.

 Izvor svetlosti se ne može zameniti.

SK:

Zdroj svetla:

Svetelný zdroj nie je možné vymeniť, pretože je vďaka svojej konštrukcii pevne spojený s produktom. Tento výrobok obsahuje svetelný zdroj triedy energetickej účinnosti <E>.

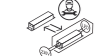
 Výmena predradníka len odborníkom.

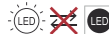
 Svetelný zdroj nie je vymeniteľný.

Sl:

Izvor svetlobe:

Vir svetlobe ni zamenljiv, ker je določen z zasnovno izdelka v okolici.

Ta izdelek vsebuje svetlobni vir razreda energijske učinkovitosti <E>.

 Zamenljiv krmilnik s strani strokovne osebe.

 Nezamenljiv vir svetlobe.

DK:

Lyskilde:

Lyskilden kan ikke udskiftes, fordi den er fast forbundet med det omgivende produkt. Dette produkt indeholder en lyskilde i energieffektivitetsklasse < E >.

 Enheden skal skiftes af en fagperson.

 Lyskilden kan ikke udskiftes.

ET:

Valgusallikas:

Valgusallikas ei ole välja vahetatav, sest ta on tootega ehituslikult kindlalt seotud.

Toode sisaldab energiatõhususe klassi <E> valgusallikat.

 Juhtimiseadise välja vahetamine professionaali poolt.

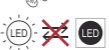
 Lamp ei ole välja vahetatav.

Fl:

Valonlähde:

Valonlähdettä ei voi vaihtaa uuteen, sillä se on rakenteellisesti yhdistetty ympäröivään tuotteeseen.

Tämä tuote sisältää valonlähteen, jonka energiatehokkuusluokka on <E>.

 Liitäntälaitteen vaihtaa ammattilainen.

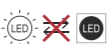
 Valonlähdettä ei voi vaihtaa.

FR:

Source lumineuse:

La source lumineuse n’est pas remplaçable car elle est, de par la construction du produit, liée de façon permanente à celui-ci.

Ce produit contient une source lumineuse de classe d’efficacité énergétique <E>.

 Remplacement du dispositif de commande par un professionnel.

 Ampoule non remplaçable.

GR:

Φωτεινή πηγή:

Η φωτεινή πηγή δεν μπορεί να αντικατασταθεί, επειδή είναι για κατασκευαστικούς λόγους σταθερά συνδεδεμένη με το προϊόν που την περιβάλλει.

Το προϊόν αυτό περιέχει φωτεινή πηγή της τάξης ενεργειακής απόδοσης <E>.

 Αντικατάσταση της διάταξης λειτουργίας από έναν επαγγελματία

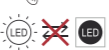
 Ο λαμπτήρας δεν μπορεί να αντικατασταθεί.

 Ο λαμπτήρας δεν μπορεί να αντικατασταθεί.

 Ο λαμπτήρας δεν μπορεί να αντικατασταθεί.

 Ο λαμπτήρας δεν μπορεί να αντικατασταθεί.

ES:

Fuente de luz:

La fuente de luz no es sustituable porque está fija en el producto desde la construcción.

Este producto contiene una fuente luminosa de la clase de eficiencia energética <E>.

 Sustitución del aparato por un profesional.

 Bombilla no reemplazable.

SE:

Ljuskälla:

Ljuskällan är inte utbytbar, eftersom den på grund av konstruktionen är fast integrerad i den omgivande produkten.

Denna produkt innehåller en ljuskälla med energieffektivitetsklass <E>.

 Byte av driftdonet genom en fackman.

 Ljuskällan är inte utbytbar.

TR:

Işık kaynağı:

Konstrüksiyon gereği çevreleyen ürün ile sabit bir şekilde bağlı olduđu için ışık kaynağı değiştirilemez. Bu ürün, <E> enerji sınıfından bir ışık kaynağına sahiptir.

 İşletme cihazının bir profesyonel tarafından değiştirilmesi.

 Aydınlatma malzemesi değiştirilemez.

UK:

Джерело світла:

Джерело світла не можна обміняти, оскільки воно міцно пов’язане з навколишнім виробом завдяки своїй конструкції.

Цей виріб містить джерело світла класу енергоефективності <E>.

 Заміна контрольної передачі професіоналом.

 Цибулини не взаємозамінні.

HU:

Fényforrás:

A fényforrás nem cserélhető, mert felépítése miatt szilárdan csatlakozik a termékhez. Ez a termék egy <E> energiahatékonysági osztályú fényforrást tartalmaz.

 Az előtétet csak szakértők cserélhetik ki.

 A fényforrás nem cserélhető

Isländisch/IS:

Ljósgrafi:

Ljósgrafinn er ekki útskiptanlegur vegna þess að hann er háður umliggjandi hönnun vörunnar.

Varan inniheldur ljósgrafa í orkuflokki <E>.

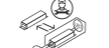
 Útskiptanlegur stýribúnaður sem fagmaður á að framkvæma.

 Ekki útskiptanlegur ljósgrafi.

IT:

Sorgente luminosa:

La sorgente luminosa non è intercambiabile perché è saldamente collegata al prodotto per via del suo design.

Questo prodotto contiene una sorgente luminosa di classe di efficienza energetica <E>.

 Sostituzione dell'alimentatore da parte di un professionista.

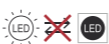
 Lampadine non intercambiabili.

HR :

Izvor svjetla :

Izvor svjetla nije zamjenjiv , jer je konstrukcijski pričvršćen na proizvod .

Ovaj proizvod sadržava izvor svjetlosti klase energetske učinkovitosti <E>.

 Izmjenu pogonskog uređaja smije izvršiti i samo profesionalna osoba

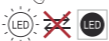
 LED žarulje nije moguće zamjeniti

LV:

Gaismas avots:

Gaismas avotu nevar nomainīt, jo tas konstrukcijā ir cieši savienots ar izstrādājuma apkārtējo daļu. Šis ražojums satur gaismas avotu, kura energoefektivitātes klase ir <E>.

 Vadības ierīci var nomainīt speciālists.

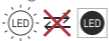
 Apgaismes līdzekli nevar nomainīt.

LT:

Šviesos šaltinis:

Šis šviesos šaltinis yra nekeičiamas, nes jis prijungtas prie gaminio pagal jo konstrukciją.

Šiame gaminyje yra šviesos šaltinis, kurio energijos vartojimo efektyvumo klasė <E>.

 Valdymo įtaisą keičia profesionalas.

 Šviesos šaltinis yra nekeičiamas.

NL:

Lichtbron:

De lichtbron kan niet worden vervangen, omdat deze vanwege de constructie vast met het product eromheen verbonden is.

Dit product bevat een lichtbron van energie-efficiëntieklasse <E>.

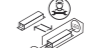
 Vervanging van het apparaat door een expert.

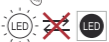
 Verlichting kan niet worden vervangen.

Norwegisch/Norwegian / NO:

Lyskilde:

Lyskilden kan ikke byttes fordi den sitter fast i produktet.

Dette produktet inneholder en lyskilde i energiklasse <E>.

 Byte av driftsapparatet må gjøres av fagmann.

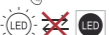
 Lyskilden kan ikke byttes ut.

PL:

Źródło światła:

Źródła światła nie można wymienić, ponieważ jest zintegrowane z produktem ze względu na swoją konstrukcję.

Ten produkt zawiera źródło światła o klasie efektywności energetycznej <E>.

 Wymiana osprzętu sterującego wyłącznie przez specjalistę.

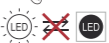
 Źródła światła nie można wymienić.

PT:

Fonte de Luz:

A fonte de luz não é substituível porque devido às suas características construtivas está fixada de forma permanente ao produto circundante.

Este produto contém uma fonte de luz da classe de eficiência energética <E>.

 Substituição do dispositivo de comando por parte de um profissional.

 Lâmpada não substituível.